

Resistance thermometer With spring-loaded tip Model TR55

WIKA data sheet TE 60.55



for further approvals
see page 2

Applications

Bearing temperature measurement on:

- Pumps
- Gears
- Motors

Special features

- Sensor ranges from -50 ... +500 °C (-58 ... +932 °F)
- Compact design
- Spring-loaded tip
- Explosion-protected versions

Description

The model TR55 resistance thermometer is ideally suited for the measurement of surface temperature at bearing shells on pumps, gears or motors under dry ambient conditions at the measuring tip. The spring-loaded, flat measuring tip ensures a constant contact pressure of the thermometer on the outer surface of the bearing shell. The optimum insertion depth can be set by means of a compression fitting.

Analogue or digital transmitters built into the connection head are capable of providing various output signals, for example 4 ... 20 mA and HART® protocol.



Fig. left: Model TR55 with connection head BSZ









Fig. right: Model TR55 with connection head JS

Explosion protection (option)

The permissible power, P_{max} , as well as the permissible ambient temperature, for the respective category can be seen on the EC-type examination certificate, the certificate for hazardous areas or in the operating instructions.







Built-in transmitters have their own EC-type examination certificate. The permissible ambient temperature ranges of the built-in transmitters can be taken from the corresponding transmitter approval. The system operator is responsible for using suitable thermowells.

Approvals (explosion protection, further approvals)

Logo	Description	Country
 	EU declaration of conformity <ul style="list-style-type: none"> ■ EMC directive ¹⁾ EN 61326 emission (group 1, class B) and immunity (industrial application) ■ RoHS directive ■ ATEX directive (option) Hazardous areas <ul style="list-style-type: none"> - Ex i Zone 0 gas [II 1G Ex ia IIC T1 ... T6 Ga] <li style="padding-left: 40px;">Zone 1 gas [II 2G Ex ia IIC T1 ... T6 Gb] <li style="padding-left: 40px;">Zone 20 dust [II 1D Ex ia IIIC T125 ... T65 °C Da] <li style="padding-left: 40px;">Zone 21 dust [II 2D Ex ia IIIC T125 ... T65 °C Db] - Ex n ²⁾ Zone 2 gas [II 3G Ex nA IIC T1 ... T6 Gc X] <li style="padding-left: 40px;">Zone 22 dust [II 3D Ex tc IIIC T440 ... T80 °C Dc X] 	European Union
 	IECEx (option) (in conjunction with ATEX) Hazardous areas <ul style="list-style-type: none"> - Ex i Zone 0 gas [Ex ia IIC T1 ... T6 Ga] <li style="padding-left: 40px;">Zone 1 gas [Ex ia IIC T1 ... T6 Gb] <li style="padding-left: 40px;">Zone 20 dust [Ex ia IIIC T125 ... T65 °C Da] <li style="padding-left: 40px;">Zone 21 dust [Ex ia IIIC T125 ... T65 °C Db] 	International
 	EAC (option) Hazardous areas <ul style="list-style-type: none"> - Ex i Zone 0 gas [0 Ex ia IIC T3/T4/T5/T6] <li style="padding-left: 40px;">Zone 1 gas [1 Ex ib IIC T3/T4/T5/T6] <li style="padding-left: 40px;">Zone 20 dust [DIP A20 Ta 65 °C/Ta 95 °C/Ta 125 °C] <li style="padding-left: 40px;">Zone 21 dust [DIP A21 Ta 65 °C/Ta 95 °C/Ta 125 °C] - Ex n Zone 2 gas [Ex nA IIC T6 ... T1] <li style="padding-left: 40px;">Zone 22 dust [DIP A22 Ta 80 ... 440 °C] 	Eurasian Economic Community
	INMETRO (option) Hazardous areas <ul style="list-style-type: none"> - Ex i Zone 0 gas [Ex ia IIC T3 ... T6 Ga] <li style="padding-left: 40px;">Zone 1 gas [Ex ib IIC T3 ... T6 Gb] <li style="padding-left: 40px;">Zone 20 dust [Ex ia IIIC T125 ... T65 °C Da] <li style="padding-left: 40px;">Zone 21 dust [Ex ib IIIC T125 ... T65 °C Db] 	Brazil
	NEPSI (option) Hazardous areas <ul style="list-style-type: none"> - Ex i Zone 0 gas [Ex ia IIC T3 ~ T6] <li style="padding-left: 40px;">Zone 1 gas [Ex ib IIC T3 ~ T6] - Ex n Zone 2 gas [Ex nA IIC T1 ~ T6 Gc] 	China

1) Only for built-in transmitter

2) Only with model BSZ or BSZ-H connection head (see "Connection heads")

Logo	Description	Country
	KCs - KOSHA (option) Hazardous areas - Ex i Zone 0 gas [Ex ia IIC T4 ... T6] Zone 1 gas [Ex ib IIC T4 ... T6]	South Korea
-	PESO (option) Hazardous areas - Ex i Zone 0 gas [Ex ia IIC T1 ... T6 Ga] Zone 1 gas [Ex ib IIC T3 ... T6 Gb]	India
	DNOP - MakNII (option) Hazardous areas - Ex i Zone 0 gas [II 1G Ex ia IIC T3, T4, T5, T6 Ga] Zone 1 Gas [II 2G Ex ia IIC T3, T4, T5, T6 Gb] Zone 20 dust [II 1D Ex ia IIIC T65, T95, T125 °C Da] Zone 21 dust [II 2D Ex ib IIIC T125 ... T65 °C Db]	Ukraine
	GOST (option) Metrology, measurement technology	Russia
	KazInMetr (option) Metrology, measurement technology	Kazakhstan
-	MTSCHS (option) Permission for commissioning	Kazakhstan
	BelGIM (option) Metrology, measurement technology	Belarus
	UkrSEPRO (option) Metrology, measurement technology	Ukraine
	Uzstandard (option) Metrology, measurement technology	Uzbekistan

Instruments marked with "ia" may also be used in areas only requiring instruments marked with "ib" or "ic".
If an instrument with "ia" marking has been used in an area with requirements in accordance with "ib" or "ic", it can no longer be operated in areas with requirements in accordance with "ia" afterwards.

Approvals and certificates, see website

Sensor

The sensor is located in the probe tip.

Measuring element

Pt100, Pt1000 (measuring current: 0.1 ... 1.0 mA) ¹⁾

Connection method	
Single elements	1 x 2-wire 1 x 3-wire 1 x 4-wire
Dual elements	2 x 2-wire 2 x 3-wire 2 x 4-wire ²⁾

Accuracy class / Range of use of the sensor per EN 60751	
Class	Sensor construction
	Thin-film
Class B	-50 ... +500 °C -50 ... +250 °C
Class A ³⁾	-30 ... +300 °C
Class AA ³⁾	0 ... 150 °C

1) For detailed specifications for Pt100 sensors, see Technical information IN 00.17 at www.wika.com.

2) Not with 3 mm diameter

3) Not with 2-wire connection method

The combinations of a 2-wire connection with class A or class AA are not permissible, since the lead resistance of the measuring insert negates the higher sensor accuracy.

Electrical connection (colour code per IEC/EN 60751)

■ Connection head form B

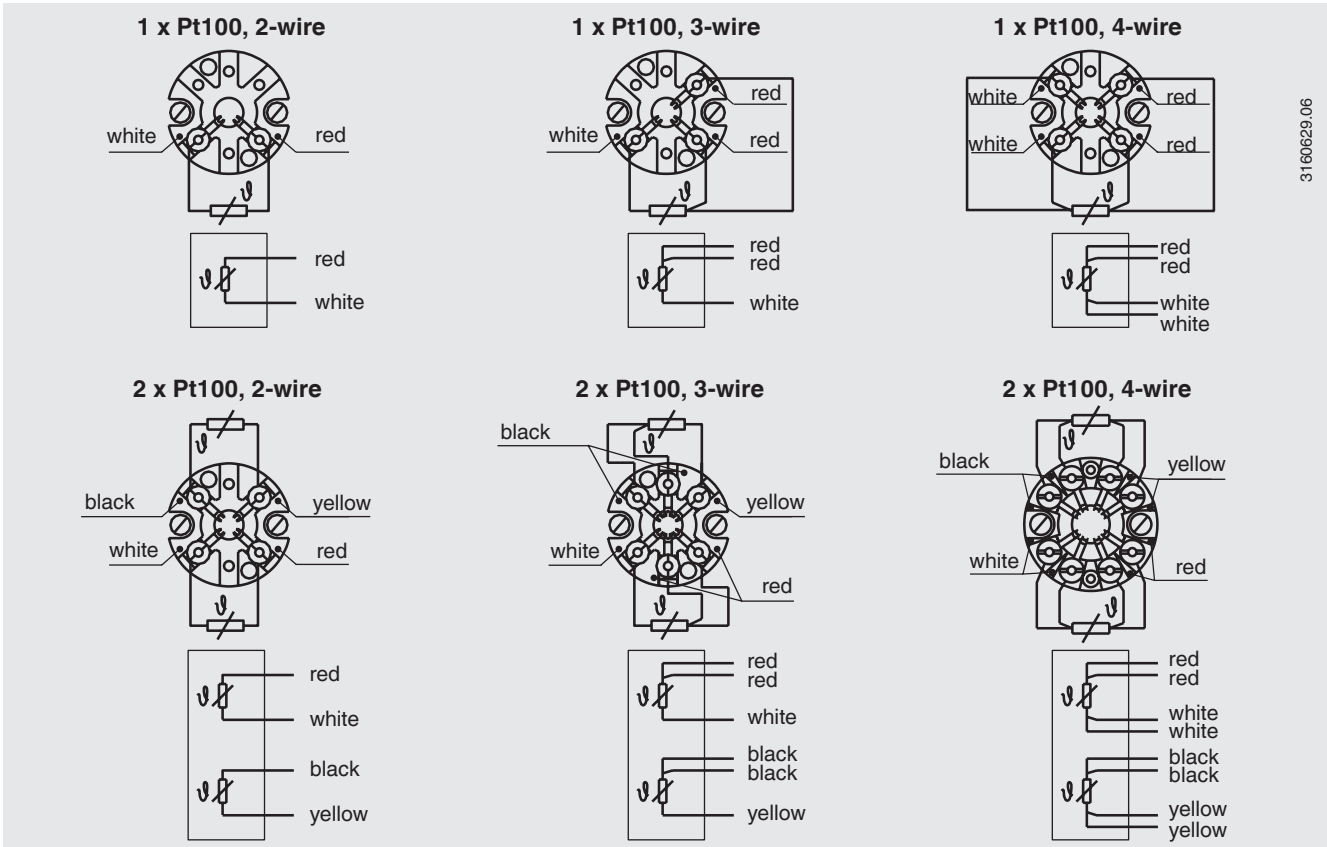

3160629.06

■ Connection head model JS

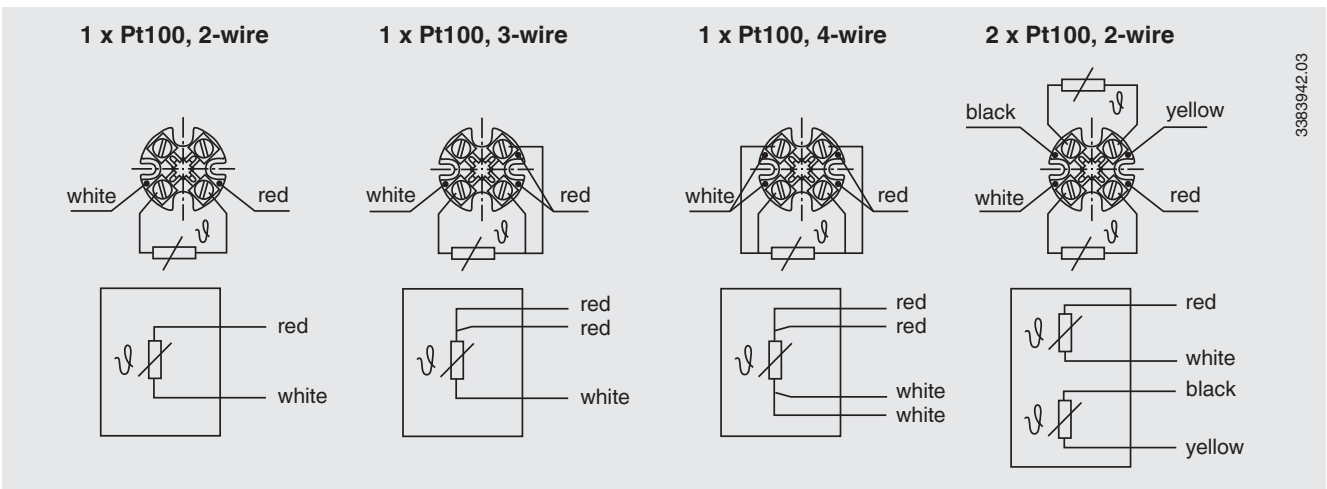

3383942.03

For the electrical connections of built-in temperature transmitters see the corresponding data sheets or operating instructions.

Connection head

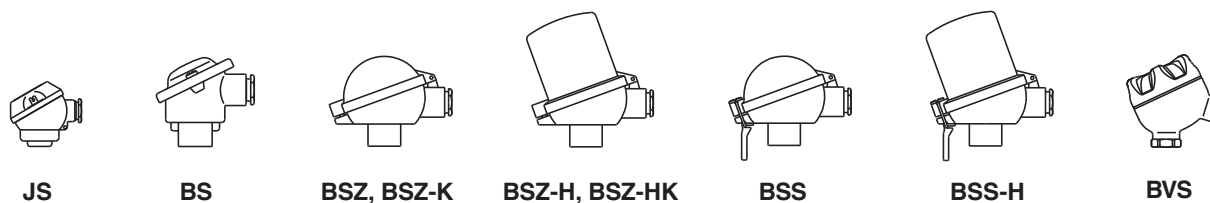

Model	Material	Cable entry thread size	Ingress protection (max.) ¹⁾	Cap	Surface	Connection to neck tube
JS	Aluminium	M16 x 1.5 ²⁾	IP65	Cover with 2 screws	Blue, lacquered ⁴⁾	M24 x 1.5, ½ NPT
BS	Aluminium	M20 x 1.5 ²⁾	IP65 ³⁾	Flat cover with 2 screws	Blue, lacquered ⁴⁾	M24 x 1.5, ½ NPT
BSZ	Aluminium	M20 x 1.5 ²⁾	IP65 ³⁾	Spherical hinged cover with cylinder head screw	Blue, lacquered ⁴⁾	M24 x 1.5, ½ NPT
BSZ-H	Aluminium	M20 x 1.5 ²⁾	IP65 ³⁾	Raised hinged cover with cylinder head screw	Blue, lacquered ⁴⁾	M24 x 1.5, ½ NPT
BSS	Aluminium	M20 x 1.5 ²⁾	IP65	Spherical hinged cover with clamping lever	Blue, lacquered ⁴⁾	M24 x 1.5, ½ NPT
BSS-H	Aluminium	M20 x 1.5 ²⁾	IP65	Raised hinged cover with clamping lever	Blue, lacquered ⁴⁾	M24 x 1.5, ½ NPT
BVS	Stainless steel	M20 x 1.5 ²⁾	IP65	Precision-cast screw-on lid	Blank, electropolished	M24 x 1.5
BSZ-K	Plastic	M20 x 1.5 ²⁾	IP65	Spherical hinged cover with cylinder head screw	Black	M24 x 1.5
BSZ-HK	Plastic	M20 x 1.5 ²⁾	IP65	Raised hinged cover with cylinder head screw	Black	M24 x 1.5

Model	Explosion protection				
	Without	Ex i (gas) Zone 0, 1, 2	Ex i (dust) Zone 20, 21, 22	Ex nA (gas) Zone 2	Ex tc (dust) Zone 22
JS	x	x	x	-	-
BS	x	x	-	-	-
BSZ	x	x	x	x	x
BSZ-H	x	x	x	x	x
BSS	x	x	-	-	-
BSS-H	x	x	-	-	-
BVS	x	x	-	-	-
BSZ-K	x	x	-	-	-
BSZ-HK	x	x	-	-	-

1) The ingress protection refers to the connection head, for information on the cable glands, see page 6

2) Standard (others on request)

3) Ingress protections, which describe temporary or lasting submersion, available on request

4) RAL 5022

Cable entry



The pictures show examples of connection heads.

Cable entry	Cable entry thread size
Standard cable entry ¹⁾	M20 x 1.5
Plastic cable gland (cable Ø 6 ... 10 mm) ¹⁾	M20 x 1.5
Nickel-plated brass cable gland (cable Ø 6 ... 12 mm)	M20 x 1.5
Stainless steel cable gland (cable Ø 7 ... 12 mm)	M20 x 1.5

Cable entry	Colour	Ingress protection (max.) ²⁾	Min./max. ambient temperature	Explosion protection				
				without	Ex i (gas) Zone 0, 1, 2	Ex i (dust) Zone 20, 21, 22	Ex nA (gas) Zone 2	Ex tc (dust) Zone 22
Standard cable entry ¹⁾	Blank	IP65	-40 ... +80 °C	x	x	-	-	-
Plastic cable gland ¹⁾	Black or grey	IP66 ³⁾	-40 ... +80 °C	x	-	-	-	-
Plastic cable gland, Ex e ¹⁾	Light blue	IP66 ³⁾	-20 ... +80 °C (standard) -40 ... +70 °C (option)	x	x	x	-	-
Plastic cable gland, Ex e ¹⁾	Black	IP66 ³⁾	-20 ... +80 °C (standard) -40 ... +70 °C (option)	x	-	-	x	x
Brass cable gland, nickel-plated	Blank	IP66 ³⁾	-60 ⁴⁾ / -40 ... +80 °C	x	-	-	-	-
Brass cable gland, nickel-plated, Ex e	Blank	IP66 ³⁾	-60 ⁴⁾ / -40 ... +80 °C	x	x	x	x	x
Stainless steel cable gland	Blank	IP66 ³⁾	-60 ⁴⁾ / -40 ... +80 °C	x	x	x	-	-
Stainless steel cable gland, Ex e	Blank	IP66 ³⁾	-60 ⁴⁾ / -40 ... +80 °C	x	x	x	x	x

1) Not available for BVS connection head

2) IP ingress protection of the cable gland. The IP ingress protections of the complete instrument TR55 must not inevitably correspond to the cable gland.

3) Ingress protections, which describe temporary or lasting submersion, available on request

4) Special version on request (only available with selected approvals), other temperatures on request

Ingress protection per IEC/EN 60529

Degrees of protection against solid foreign bodies (defined by the first index number)

First index number	Degree of protection / short description	Test parameter
5	Dust-protected	per IEC/EN 60529
6	Dust-tight	per IEC/EN 60529

Degrees of protection against water (defined by the second index number)

Second index number	Degree of protection / short description	Test parameter
4	Protected against splash water	per IEC/EN 60529
5	Protected against water jets	per IEC/EN 60529
6	Protected against strong water jets	per IEC/EN 60529
7 ¹⁾	Protected against the effects of temporary immersion in water	per IEC/EN 60529
8 ¹⁾	Protected against the effects of continuous immersion in water	by agreement

1) Ingress protections, describing temporary or permanent immersion, on request

Standard ingress protection of model TR55 is IP65.

The stated degrees of protection apply under the following conditions:

- Use of a suitable cable gland
- Use of a cable cross-section appropriate for the gland or select the appropriate cable gland for the available cable
- Adhere to the tightening torques for all threaded connections

All IP specifications apply to the area above the fully assembled compression fitting (see also support tube page 11).

Transmitter

Mounting onto the measuring insert

With mounting on the measuring insert, the transmitter replaces the terminal block and is fixed directly to the terminal plate of the measuring insert.

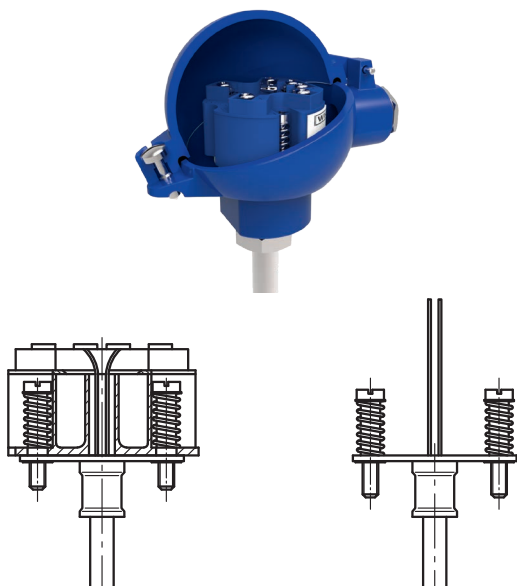
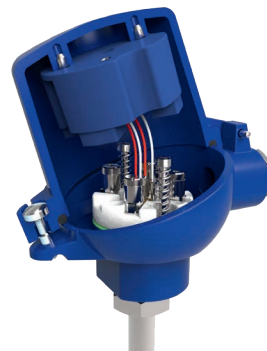

Fig. left: Measuring insert with mounted transmitter (here: model T32)
 Fig. right: Measuring insert prepared for transmitter mounting

Mounted within the cap of the connection head

Mounting the transmitter in the cap of the connection head is preferable to mounting it on the measuring insert. With this type of mounting, for one, a better thermal insulation is ensured, and in addition, exchange and mounting for servicing is simplified.



Transmitter models



Output signal 4 ... 20 mA, HART® protocol				
Transmitter (selectable versions)	Model T15	Model T32	Model T91.10	Model T91.20
Data sheet	TE 15.01	TE 32.04	TE 91.01	TE 91.01
Output				
■ 4 ... 20 mA	x	x	-	x
■ 0 ... 10 V	-	-	x	-
■ HART® protocol	-	x	-	-
Connection method				
■ 1 x 2-wire	x	x	x ¹⁾	x
■ 1 x 3-wire	x	x	x	-
■ 1 x 4-wire	x	x	-	-
Measuring current	< 0.2 mA	< 0.3 mA	0.8 ... 1 mA	0.8 ... 1 mA
Explosion protection	Optional	Optional	-	-

1) Please observe the transmitter data sheet.

Possible mounting positions for transmitters

Connection head	T15	T32	T91.10	T91.20
JS	-	-	-	○
BS	○	-	○	-
BSZ, BSZ-K	○	○	○	-
BSZ-H, BSZ-HK	●	●	●	-
BSS	○	○	○	-
BSS-H	●	●	●	-
BVS	○	○	○	-

○ Mounted instead of terminal block

● Mounted within the cap of the connection head

- Mounting not possible

The mounting of a transmitter on the measuring insert is possible with all the connection heads listed here.

For a correct determination of the overall measuring deviation, the sensor and transmitter measuring deviations must be added.

Components model TR55

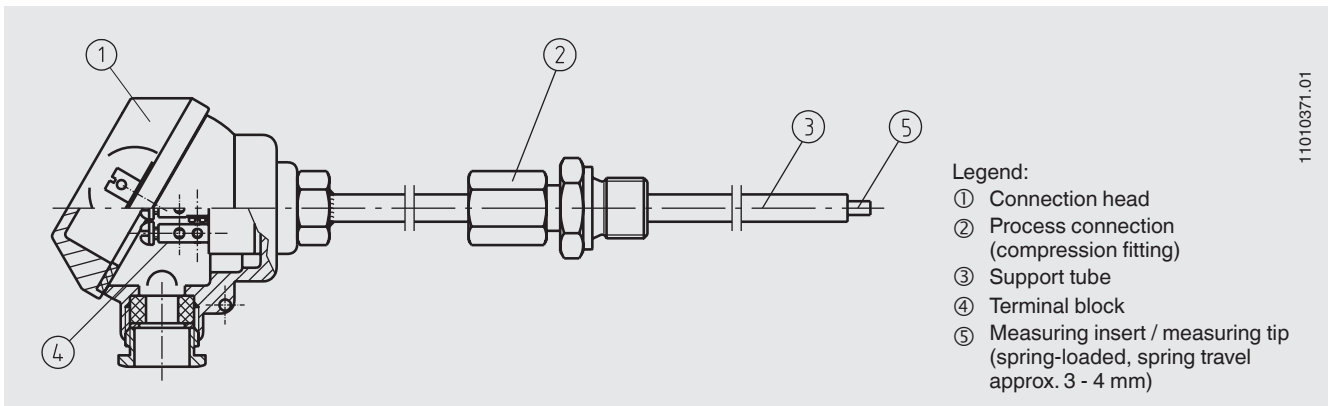

11010371.01

Dimensions in mm

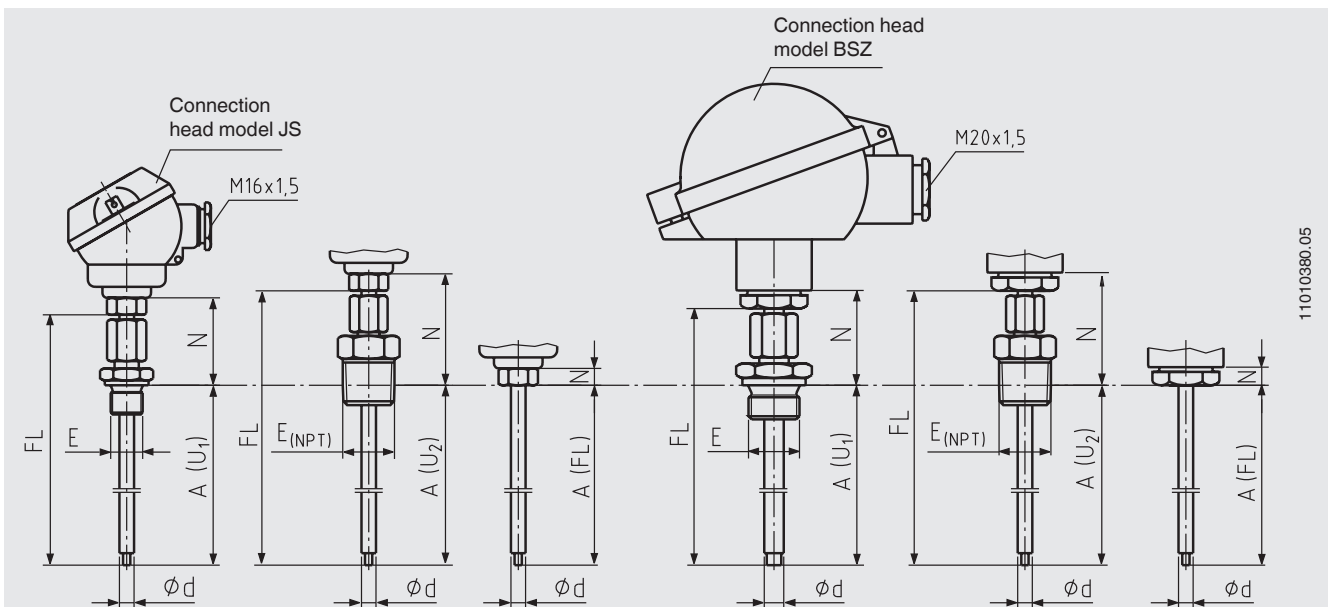

11010380.05

The combinations of process connection and connection head shown above are examples.

Legend:

- A Insertion length
- E Thread
- Ø d Support tube diameter
- N Neck length
- FL Probe length

Support tube

Serves for the fastening of the compression fitting only and is open at the measuring tip (not water-, dust- or gas-tight).

■ Material: Stainless steel

Support tube Ø in mm	Process connection	Maximum possible insertion length A ¹⁾ in mm with probe length FL							
		65	75	80	85	105	125	230	250
6 or 8	G ¼ B	35	45	50	55	75	95	200	220
	G ⅜ B	35	45	50	55	75	95	200	220
	G ½ B	35	45	50	55	75	95	200	220
	¼ NPT	20	30	35	40	60	80	185	205
	½ NPT	20	30	35	40	60	80	185	205

1) Spring not loaded, spring travel approx. 3 to 4 mm (tolerance of insertion lengths ±2 mm)

Diameter support tube / measuring tip

Connection head JS: Ø 6.0 / 3.0 mm

Connection heads, form B: Ø 6.0 / 3.0 mm or 8.0 / 6.0 mm

Compression fitting

All compression fittings are manufactured from stainless steel. Other materials are available on request.

The compression fitting enables simple, on-site adjustment to the required insertion length.

Due to the length of the compression fitting itself, the minimum neck length N is 40 mm for parallel threads and 55 mm for NPT threads.

Ferrule material: Stainless steel

Ferrules from stainless steel are only adjustable once; once the fitting has been loosened, sliding along the thermowell is no longer possible.

Ferrules from PTFE are not recommended for this application due to vibration and thermal loading.

On delivery, the compression fittings are only tightened hand-tight. Insertion length A and neck length N (M_H) can thus be checked. The final positioning/fixing of the compression fitting is carried out at the installation location.

Neck length N (M_H)

The neck length depends on the intended use. Usually an isolation is bridged by the neck tube. Also, in many cases, the neck tube serves as a cooling extension between the connection head and the medium, in order to protect a possible built-in transmitter from high medium temperatures.

Measuring insert

Specifications, removable design	
Description	The measuring insert is spring-mounted with two screws into the connection head and can simply be removed for calibration purposes. The thermowell itself can thus remain in the process. The terminal block for electrical connection is connected to the probe tube of the measuring insert.
Diameter (for thermowell Ø = 6 mm)	3 mm
Diameter (for thermowell Ø = 8 mm)	6 mm
Operating temperatures (dependent upon the sensor design type and the accuracy class)	Min: -40 °C Max: +600 °C
Built-in measuring insert model	TR10-A

Operating conditions

Ambient and storage temperature

-40 ... +80 °C

Other ambient and storage temperatures on request

Certificates (option)

Certification type	Measurement accuracy	Material certificate
2.2 test report	x	x
3.1 inspection certificate	x	x

The different certifications can be combined with each other.

Ordering information

Model / Sensor / Explosion protection / Connection head / Terminal block, transmitter / Output signal / Process connection / Version and material of the threaded connection / Support tube diameter / Thread size / Measuring element / Connection method / Temperature range / Insertion length A / Neck length N(M_H) / Certificates / Options

© 07/2015 WIKA Alexander Wiegand SE & Co. KG, all rights reserved.
The specifications given in this document represent the state of engineering at the time of publishing.
We reserve the right to make modifications to the specifications and materials.

